

TORO

Network VP™ 4.00 Satellite User's Guide

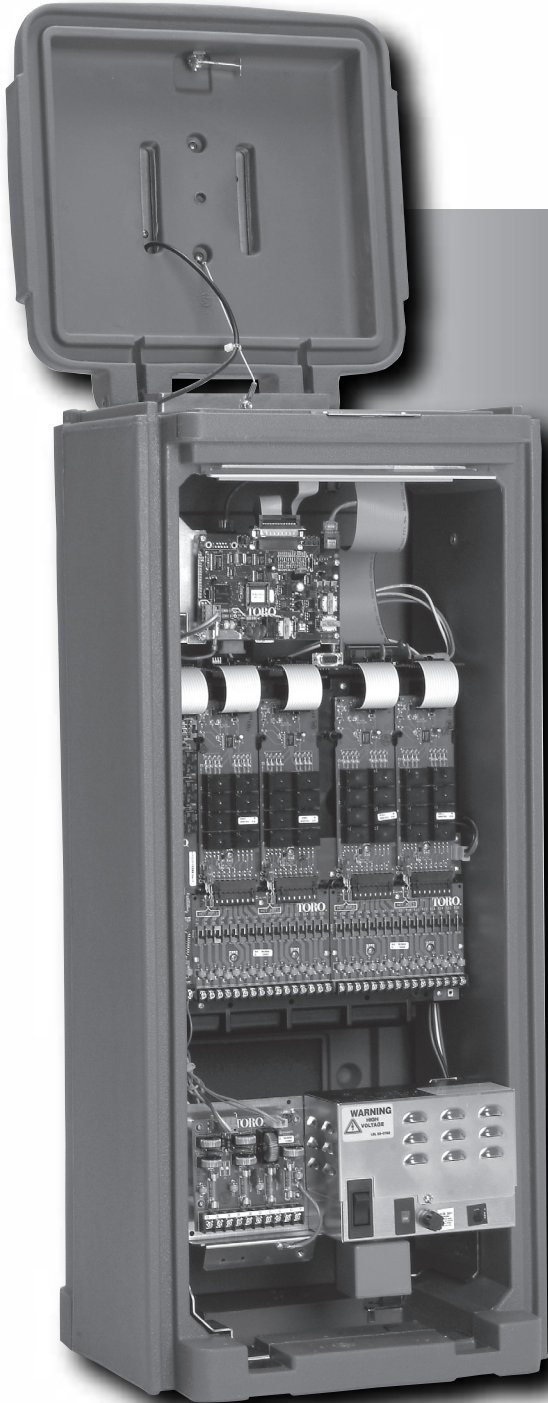

- **16 to 64 stations in eight-station increments**
- **Field programmable for future upgrades**
 - **Does not require EPROM(s) replacement**
- **Operates as a stand-alone controller or under the management of a central computer.**
 - **Supports wireline or radio communications with the central computer**
 - **Supports hybrid communication (wireline and radio) for increased flexibility and cost effectiveness**
- **64 irrigation programs:**
 - **Independent stand-alone and central operation**
- **Basic, Advanced and Grow-In programs with unique capabilities to meet your needs**
- **Multi-Manual, Program Start and Syringe manual operations**
- **Operates up to 32 stations simultaneously**
- **Backwards compatible with Network 8000**

Index

Radio Specifications	3
Fuse and Circuit Breaker Specifications	3
Satellite Controller Specifications	3
Introduction	4
Modes of Operation	4
General Editing	4
Timing Mechanism Components	5
Distribution Board Components	6
Output Board Components	6
Pump / Common Board Components	7
Communication Board Components	7
Power-Up Diagnostics	8
Home Key	8
Start Key	9
Pause / Resume Key	10-11
Stop Key	11
Satellite Settings	12-13
Station Settings	14-15
Scheduled Watering	16-21
• Basic Irrigation Program	17
• Advanced Irrigation Program	18
• Grow-In Irrigation Program	19
• GMM (Group Multi-Manual Function)	20
• Station Based Flow Management	21
Manual Watering	22-23
• Multi-Manual	22
• Manual Syringe	23
• Manual Program	23
% (Percent) Adjust	24
Diagnostics	24-25
Trouble Shooting Guide	26-27
Lithium Battery Replacement	Back Cover
Electromagnetic Compatibility	Back Cover

Radio Specifications

Equipment Type – Data radio, MAXON, model SD-125 U2

Frequency Band – UHF

RF Output Power – 2.0 watt

Current Consumption:

Standby (Muted) – < 65 mA

Transmit 2 watts RF power – < 1.0A

FCC License: FCC ID# MNT-PC-UC

Fuse & Circuit Breaker Specifications

Power Supply:

1.5A On/Off Switch/Circuit Breaker – Main Power Input

3.2A Fuse (Slow-Blow) – Field Output

4.0A Circuit Breaker – Control Functions (Timing Mechanism)

Output Board : 3A Fuse

Communication Board :

0.5A Fuse – Communication Line Protection

7.5A Fuse – Common Line Protection

0.5A Fuse – Pump Line Protection

Pump/Common & Communication Surge Protection Module (optional): 1A Fuse

Satellite Controller Specifications

Line Voltage: 115-120 or 230-240 VAC 50/60 Hz (switchable), 130 VA

Current Draw (no load): 0.21A @ 115-120 VAC, 60 Hz or 0.10A @ 230-240 VAC, 50 Hz

Current Draw (maximum load): 0.91A @ 115-120 VAC, 60 Hz or 0.45A @ 230-240 VAC, 50 Hz

Current Load (based on available 24 VAC)

Maximum Current Available for Load: 3.0A (72 VA)

Maximum Load Per Station: 0.75A (18 VA)

Maximum Load Per Pump/Master Valve: 1A (24 VA)

Operating Temperature: -10°C to +60°C (14°F to 140°F)

Storage Temperature: -30°C to +65°C (-22°F to 149°F)

Introduction

The Toro Network VP™ Satellite combines modular flexibility, ease of use and increased programmability in a single controller.

Modularity means flexibility. The Network VP is available from 16 to 64 stations, and can expand in eight-station increments to meet your needs. Optional station switch capability and surge protection provide simple operation and added security.

The intuitive Network VP user interface is easy to use and includes a backlight for improved visibility in low-light conditions, yet it is completely viewable in direct sunlight. The faceplate's combination of menu keys, navigation arrows and input dial allows for easy menu navigation and quick settings establishment.

With 64 irrigation programs, the Network VP allows programming to the station level. Discrete local and central modes make stand-alone and central controlled operations independent from one another, while the ability to run up to 32 stations simultaneously lets you deliver more water, quicker than ever before.

Modes of Operation

The Network VP satellite can be placed in three operating modes: Central mode, Local mode and Off mode. In all three modes, the satellite will accept communications from SitePro™. Select the mode of operation by pressing the

Satellite Settings  and selecting **Comm Mode**. Select from the three modes using the

Input Dial .



Central Mode - When placed in Central Mode, the satellite will allow SitePro to download irrigation programs, edit time and date and modify the satellite's operation mode. If communication between central and satellite is interrupted for more than one hour, the Central Mode LED indicator will start flashing until communication is reestablished.

Note: Only SitePro 2.1 or later can modify the satellite's operation mode. Previous SitePro versions are not capable of this operation.

Local Mode - When placed in Local mode, the satellite will execute previously downloaded or locally configured irrigation programs. In this mode, the satellite will allow the central to edit time, date and operation mode but will not allow modification of settings affecting irrigation programs.

Off Mode - When placed in Off mode, the satellite will not execute any watering operation whether it is program or manually initiated. Any watering operation will terminate once the satellite is placed in Off mode. Watering operations will resume once the satellite is placed back to Central or Local mode. In this mode, the satellite will allow the central to edit time, date and operation mode but will not allow modification of settings affecting irrigation programs.

General Editing

Pressing a menu key on the Network VP satellite will display menu items. Items with fields containing values that can be edited are called Entry Fields. Use the Arrow Keys  to navigate through the menus and entry fields. Modify any selected value by scrolling through the selection using the Input Dial .

Values will be saved automatically when you exit an entry field or press another menu key. Pressing the HOME Key  will also save any modification and revert back to Home display.

Additionally, if no keypad activity is detected within five minutes, the satellite will automatically save any modifications and revert back to Home display.

Timing Mechanism Components

1  **Left and Right Arrows** allow you to select the next entry field within the same menu line. Any changes will be saved after you exit that entry field.

2  **Up and Down Arrows** allow you to scroll up and down through the menu items.

3 **Operation Mode LED Display** will indicate the current satellite operation mode.

4 **LCD Panel** is the display screen.

5  **Input Dial** allows you to scroll through the value selection within the selected entry field.

6  **Home Key** allows you to exit from any function menu and return the satellite to normal operation. After pressing the Home Key, all modifications to the settings will be saved.

7  **Manual Watering Menu Key** allows you to activate station(s) or program(s) manually.

8  **Scheduled Watering Menu Key** allows you to modify each irrigation program's parameter. Use this function to assign the program start times, end times, delay times, stations, runtimes, repeats and maximum simultaneous stations per program.

9  **Diagnostics Menu Key** allows you to view the satellite's firmware version as well as sequentially activate each stations momentarily. Use this function to troubleshoot the system.

10  **Station Settings Menu Key** allows you to modify station parameters. Within this setting, you can specify each station's percent adjust, disable the station from any activity, hold station watering for a specific number of days, set the station type to a switch and create or edit the station description/name.

11  **Percent Adjust Menu Key** allows you to adjust watering to a specific percentage range. The user can specify percentage adjustment for satellite, programs and stations.

12  **Start Key** will execute selected program or manual operation.

13  **Pause/Resume Key** will pause currently activated program(s). Press the key while in pause and select Resume to continue operation.

14  **Stop Key** will cancel currently running program(s) or station(s).

15  **Satellite Settings Menu Key** allows the user to modify the satellite parameters. Users can specify the satellite communication mode, hold duration for satellite's activity, the language, clock settings, date, day change, CSG address, satellite address, station delay, maximum number of stations to run simultaneously, units and display contrast. Within this menu, the user can also reset all programs, reset the station parameters and reset all disables.

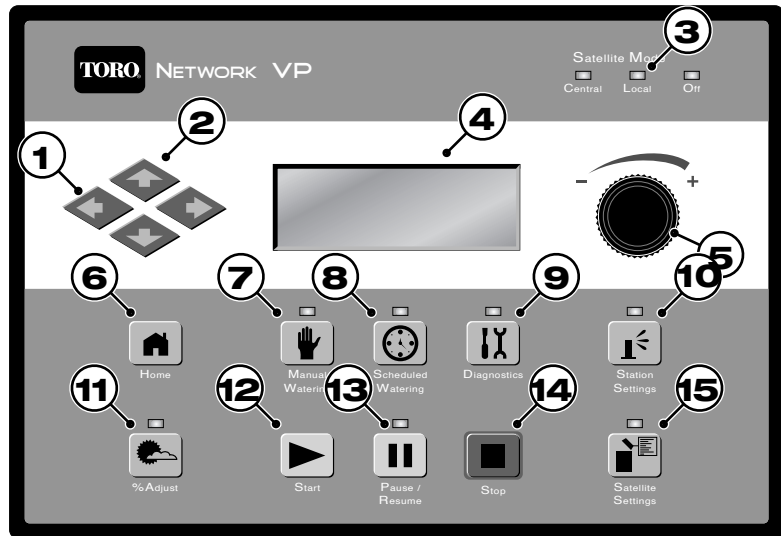

Distribution Board Components

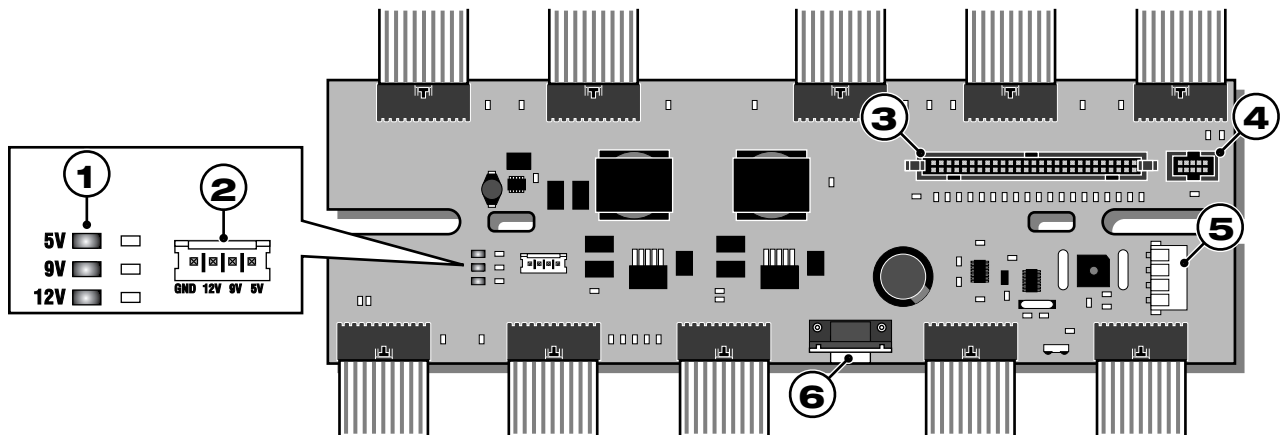

- 1 5V, 9V and 12V LED Indicator** - When illuminated, the LED indicates the presence of the corresponding voltage in the satellite's circuitry.
- 2 GND, 12V, 9V and 5V Sources** - Voltage source pins provide terminals for monitoring the satellite's internal voltages with the use of a digital multi-meter or an oscilloscope.
- 3 Timing Mechanism Cable Socket** - VP Timing Mechanism data cable connection socket.
- 4 Data Cable Socket** - (For future use.)
- 5 Power Source Socket** - 15 VAC input power cable from the satellite's transformer.
- 6 RS-232 Data Socket** - The RS-232 Data connector enables the satellite to interface with a laptop or Hand-Held PC.

Output Board Components

- 1 Output Board LED Indicator** - When illuminated, the LED indicates that power is present at the output board.
- 2 Station LED Indicator** - When illuminated, the LED indicates that the corresponding station output has been activated.
- 3 Output Board Fuse** - Each output board is equipped with a 3A fuse. Placing individual fuse to each board enables the satellite to bypass any shorted output board and continue operation to the remaining output boards.
- 4 Fuse LED Indicator** - When illuminated, the LED indicates that the fuse is functional.
- 5 Standard Station terminal Connector** - If no additional surge protection is needed, the standard station terminal connector is sufficient for station connection.
- 6 Surge Output Board** - The surge output board is used in lightning prone areas where additional surge protection is needed. The Surge Output board also allows the user to manually activate or deactivate any station with a switch.

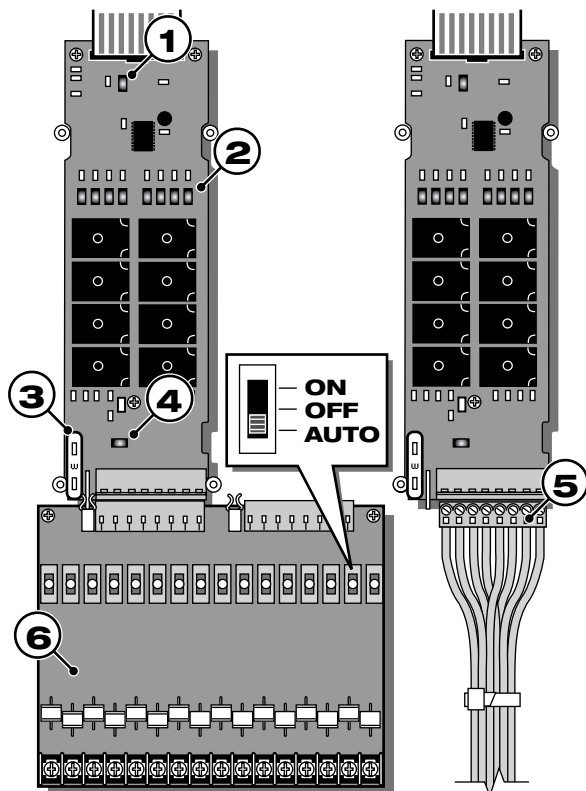

Pump / Common Board Components

- 1 Pump Terminal Switch** - The Pump terminal can be placed in **ON**, **OFF** or **Auto** with this switch.
- 2 Common Terminal Switch** - The Common terminal can be placed in **ON**, **OFF** or **Auto** with this switch.
Note: The Common switch must be set to **ON** when activating a station using the output board station switch.
- 3 Pump LED Indicator** - When illuminated, the LED indicates activation of the pump terminal.
- 4 Common LED Indicator** - When illuminated, the LED indicates the activation of the 1st common terminal.
- 5 Common LED Indicator** - When illuminated, the LED indicates the activation of the 2nd common terminal.
- 6 24 VAC Indicator** - When illuminated, the LED indicates that the 24 VAC in the Pump/Common output board and the fuse are functional.
- 7 Pump/Common Board Fuse** - The Pump/Common output board is equipped with a 1A fuse.
- 8 Output LED Indicator** - When illuminated, the LED indicates the presence of voltage at the pump terminal output.

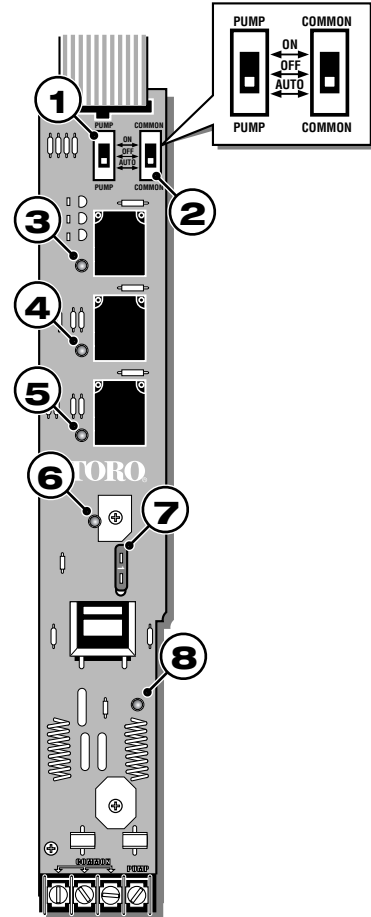

Communication Board Components

- 1 Communication Data Socket** - Timing mechanism interface
- 2 Power Supply Socket** - Pump/Common board interface
- 3 0.5A Fuse** - Communication Line Protection
- 4 0.5A Fuse** - Communication Line Protection
- 5 7.5A Fuse** - Common Line Protection
- 6 0.5A Fuse** - Pump Line Protection

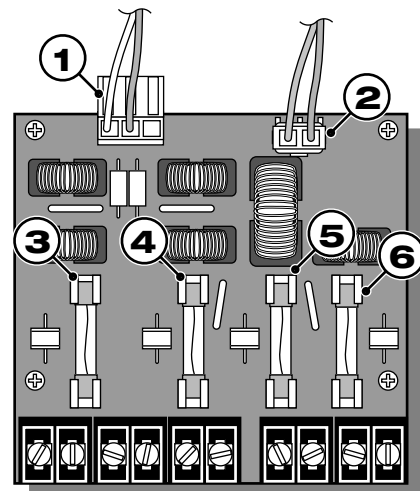

Power-Up Diagnostics

Upon power-up, the satellite will display:

Network VP

Booting

The Network VP Satellite will initiate a diagnostic test automatically during power-up. This function will take approximately ten seconds and it can not be bypassed. If a problem is detected during the diagnostic test, it will be indicated on the display. These status information can not be edited. The information is as follows:

Line 1: Network VP Firmware Version and Revision Date

Line 2: Detect: [xx stations, yy sensors] (xx = number of stations detected, yy = number of sensors detected)

Line 3: Last Power Downtime Date and Time

Example:

Rev: 4.00 09/15/10
Detect: 64sta, 00sen
PD - 09/16/10

The default Home display will follow after the diagnostic display has timed-out.

Home display example:

Sun 04/02/06 02:31 pm
Sat# 001-001 Sec: 57
Day Change: 12:00am

Home Key



Pressing the Home Key will revert to the default display. When editing irrigation programs, Station or Satellite settings, pressing the Home Key will save any setting modifications and return the user to the Home display.

Home display examples:

Sun 04/02/06 02:31 pm (Typical Home display with no active scheduled program)
Sat# 001-001 Sec: 57
Next start: 03:00am

Sun 04/02/06 02:31 pm (Home display with two active scheduled programs)
Sat# 001-001 Sec: 57
Running 02 programs (Use the down arrow  button to access hidden display lines on the screen)
P01 Sta01 00:09:46
P05 Sta25 00:19:51

The Day Change line will display the next program start time (**Next Start: HH:MM**) if the current day is an active watering day. If the satellite is running a program, the Day Change line will display **Running XX programs** to indicate the number of active programs.

If the satellite has an active running program, the display will read:

Sun 04/02/06 02:31 pm
Sat# 001-001 Sec: 57
Running 04 prg+ Man (Running Multi-Manual)

P01 Sta01 %00:05:00 (The “%” symbol before the runtime indicates that station 01 is percent adjusted.)
P01 Sta02 00:05:00 (P01 indicates Program 01 is currently active)
P01 Sta03D 00:05:00 (The “D” symbol after the station number indicates that station 03 is disabled.)
P02 Sta10P 00:05:00 (The “P” symbol after the station number indicates that program 02 is paused.)
P03 Soak04 00:00:32 (“Soak” indicates that Station 04 of Program 03 is active and in the soak transition.)
GMM Sta35 00:15:00 (GMM indicates that Group Multi-Manual is active)
Man Sta21 00:10:00 (“Man” indicates Manual Watering is currently active)
Man Sta22S 00:10:00 (The “S” symbol after the station number indicates that program 02 is stacked.)

Note: Program stacking occurs when the satellite is running a program where the maximum simultaneous station limit is surpassed. Additional scheduled programs will be stacked (delayed) until an available station can be activated.

Start Key



Use the Start key to execute a manual function.

Note: Pressing the Start key while the satellite is idle will prompt the Manual Watering menu.

Multi-Manual Start Display

Multi-Manual

Starting

03 (3-second countdown)

STOP to cancel

Manual Syringe Start Display

Syringe Starting

Program 01

03 (3-second countdown)

STOP to cancel

Manual Start Program Display

Program 01

Starting

03 (3-second countdown)

STOP to cancel

Group Multi-Manual (GMM) Start Program Display

GMM

Starting

03 (3-second countdown)







STOP to cancel

Pause / Resume Key

 The Pause command is used to suspend active program or manual irrigation. The Pause function allows the user to specify the pause duration.

Pause / Resume Function Directions

Pause function example: Program 01 has been manually activated. Pause program 01 for 30 minutes.



1. Press the Pause  key.
2. Use the Input Dial -  + to select All, M-Man or Prg:XX (XX = the program number). If multiple programs are active, use the Right Arrow key  to tab to the program number field before using the Input Dial to select the correct program number. For this example, select **Prg: 01**.
3. Press the Down Arrow  to advance the cursor to the **for:** field. Use the Input Dial -  + and the Right Arrow key  to select the pause duration in hours and minutes. For this example, set the pause duration to **00 hr 30 min**.

The display should read:

*Pause: Prg: 01
for: 00 hr 30 min (The default pause time is 00 hr 05 min minutes)
Press PAUSE to pause
00 Programs paused*

4. Press the Pause  key to initiate the Pause function.

Resume Satellite Activity example: Reactivate Program 01 watering.

1. Press the Pause  key.
2. Use the Input Dial -  + until the correct program or multi-manual operation is displayed.
For this example, select **Resume: Prg: 01**.

The display should read:

*Resume: Prg: 01
Push PAUSE to resume
01 Programs paused*

3. Press the Pause  key to release the Pause function.

Pause Function

Pause Program XX

Satellite Action

Allow the start of other programs, multi-manuals and syringe. If the start time of the paused program occur's again while still on Pause, that runtime will be stacked (delayed until the first occurrence is completed).

If Program XX is already on Pause or Pause All is in effect, the new pause time-out will override the remaining pause time for program XX.

Pause Multi-Manual

Allows any program or syringe start. If the 1st multi-manual is Paused and a second multi-manual is started, the 1st multi-manual (Paused) will resume and the second multi-manual that was sent will be stacked.

If Multi-Manual is already on Pause or Pause All is in effect, the new pause time-out will override the remaining pause time for the multi-manual.

Pause Syringe

Allows any program or manual start. If a new syringe is activated for the same paused syringed program, the pause will be cancelled and activity will resume with the new runtime.

If a syringed program is on Pause All, activating a new pause for the same syringe program will overwrite the remaining pause time with the new pause time for that syringed program.



Pause All	All currently running programs, multi-manual and syringe will be suspended until the pause time-out expires. New start is allowed only for Manual functions. Additional programs that are scheduled to start while Pause All is in effect will be stacked until the Pause time-out expires.
Pause All Timed out	All activity delayed by Pause All function will resume. Programs and Manual functions that were paused after the Pause All function will resume when their pause time-out expires.
Resume Program XX	Resumes program XX activity.
Resume Multi-Manual	Resumes multi-manual activity.
Resume Syringe	Resumes syringe activity.
Resume All	Resumes all irrigation activity.
Cancel (Stop) Program XX	If Program XX is paused, the pause status will be cancelled and activity terminated. If the same program is stacked, it will also be terminated.
Cancel (Stop) Manual	If Manual activity is paused, the pause status will be cancelled and the manual activity is terminated.
Cancel (Stop) All	All paused activities will be cancelled and all watering will be terminated.

Stop Key

 Use the Stop function to cancel program or manual irrigation. If the Network VP satellite has no current activity, pressing the Stop key will have no effect.

Stop Function Directions

Stop Function Example: Program 01 is activated automatically. Cancel watering for program 01.

1. Press the Stop  key.
2. Use the Input Dial -  + until the desired program or station to be cancelled is displayed.
For this example, select **Cancel: Prg: 01**.

The display should read:

Cancel: Prg: 01

STOP to cancel water

Running 01 programs

P01 is running

3. Press the Stop  key to finalize the program cancelation.

When finished, the display should read:

Canceling P01

Watering

03 (3-second countdown)

STOP to escape

Satellite Settings

 Satellite Settings allows you to set satellite parameters such as Time, Date and Language.

Use the Up or Down Arrows   to navigate through the menus.



Use the Left and Right Arrow   to advance to the next entry field on the same menu line.

Use the Input Dial -  + to select values when editing.

Comm Mode: – Use this menu item to select the satellite mode of operation between Central, Local or Off mode.



Hold All: – Use this menu item to suspend satellite operation and choose the suspension duration from Today, 02-30 days, Permanent or None.

Hold Rain: – Use this option to suspend satellite operation and choose the suspension duration from Today, 02-30 days, Permanent or None. When activated, Hold Rain will cancel any current watering, along with suspending operation.

Reset Prg's: – Use this menu item to reset all satellite irrigation program by selecting Yes. After selecting Yes, press the Up or Down Arrows   to activate. The following will display:



*Reset All Programs
to defaults
05 (5-second countdown)
STOP to escape*

All program data will be erased after a successful reset.

Reset Sta's: – Use this menu item to reset all station settings by selecting Yes. After selecting Yes, press the Up or Down Arrows   to activate. The following will display:

*Reset All Stations
to defaults
05 (5-second countdown)
STOP to escape*



All station settings will be erased after a successful reset.



Reset Unit: – Use this menu item to reset the satellite settings by selecting Yes. Select **Yes** using the Input Dial -  + and press the Up or Down Arrows   to activate. The following will display:

*Reset All Defaults
10 (10-second countdown)
STOP to escape*

After the 10-second countdown, the satellite will reboot.

Resetting the unit will erase all user-defined program data and configuration values in the satellite's memory.

Enable Sta's: – Use this menu item to reset all disabled stations with one execution. This function will also clear all station alarms related to under/over current conditions. Select **Yes All** using the Input Dial -  + and press the Up or Down Arrows   to activate. Select **No** to cancel. Individual stations can be enabled/disabled by using the Disable function within the Station Settings menu.

Reset Amps: – The Network VP 3.0 automatically monitors the electrical output current for each individual stations. Network VP 3.0 ensures that each station operates properly by comparing the station's electrical current draw to a nominal value. Use this menu item to reset all stations' electrical current values. Select **Yes All** using the Input Dial -  + and press the Up or Down Arrows   to activate. Select **No** to cancel. Individual stations can be reset by using the **Nominal** function within the Station Settings menu.



Setup Amps: – Use this menu item to establish and update each of the stations’ nominal current value to the satellite’s memory. These values are used by the satellite for **Current Reaction Management (CRM)** and **Current Prediction Management (CPM)**.

CRM allows the Network VP 3.0 to react to an out-of-tolerance current condition. This condition occurs when a station’s electrical current exceeded the boundaries of the tolerance setting for that station.



CPM enables the Network VP 3.0 to manage output current of all the activated stations. As a result, Network VP 3.0 can prevent a station from activating if the total satellite output will exceed the maximum allowable current. If a station is prevented from activating because of a possible electrical current overage, the station will activate as soon as the required electrical current capacity is available.

Set Amp Tol: – Use this menu item to set the electrical current tolerance for each station. This value will determine the maximum and minimum threshold value for all stations in relation to their nominal current value. Individual station amp setting can then be modified by using the **Tol +/-** function within the Station Settings menu.

Language: – Default language is English. Future option, Spanish.

Clock Set: – Use this menu item to set the current time. Use the Left and Right Arrow Keys  to select the Hours and Minutes parameters then use the Input Dial  to modify the values.

Clock Mode: – Use this menu item to select the clock mode between Am/Pm (12-Hour) and 24-Hour mode.

Date: – Use this menu item to set the current date. Use the Left and Right Arrow Keys  to select the Month, Date and Year parameters then use the Input Dial  to modify the values.

Day Change: – Use this menu item to set the “day change” time. The “day change” is the specified time that the satellite will advance the date. The default day change is 12:00 am. Adjusting the day change time will allow programs to start throughout the night on the same active day schedule. Programs with runtimes beyond the day change time are allowed to finish.

CSG Address: – Use this menu item to set the CSG (Central Satellite Group) address. SitePro uses this address to identify different satellite groups.

Identify all satellites that can be grouped together and assign them with the same CSG address. When SitePro sends out a command to that CSG address, all the satellites within that group will receive and execute the command.

Sat Address: – Use this menu item to set the satellite address. Each satellite must be given a unique satellite address. SitePro uses this address to identify individual satellites when sending satellite specific commands.

Sta Delay: – Use this option to set the satellite’s station delay. The station delay determines the wait time before the next station is activated after a station has concluded its watering cycle. This time delay is used to allow the system to normalize between station activations.

Max Sim Sta: – Use this menu item to set the maximum number of simultaneously operating stations. This threshold will be applied to all programs and manual irrigation functions. Each program can then be set with a lower limitation if necessary.

Note: Simultaneous setting in the Watering Schedule can not exceed the Satellite Settings.

Example: The satellite is set with a maximum simultaneous active stations of **7**. All programs in the satellite will adhere to the 7 maximum active stations and each can be adjusted with a lower limit (6, 5, 4, etc.).



Meas Units: – Use this menu item to set the satellite’s unit system between English (U.S. Standard) and Metric units.

Display Adj: – Use this menu item to adjust the contrast of the LCD screen. Use the Input Dial  to darken or lighten the text display.

Station Settings

 Station Settings allows you to set parameters specific to each station.

Use the Up or Down Arrows   to navigate through the menus.

Use the Left and Right Arrow Keys   to advance to the next entry field on the same menu line.

Use the Input Dial -  + to select values when editing.

S01 – Select the station you want to edit in this field. Choose from Station 01 through the satellite maximum station count of 64.

100% – If weather or other condition requires irrigation program modification, it can be easily adjusted by changing the percent adjustment. Station operation can be reduced to 000% (Off) or increased up to 900%. 100% represents standard operation.

Sched Today: – This menu item will display the total scheduled station runtime for the current irrigation day.

Water Today: – This menu item will display the total station runtime that has occurred for the current irrigation day.

Note: Runtime resulting from a station that is manually activated via the output hardware switch will not be captured.

Water Yestr: – This menu item will display the total station runtime that occurred for the previous irrigation day.

Note: Runtime resulting from a station that is manually activated via the output hardware switch will not be captured.

Disable: – Use this menu item to disable station operation by selecting **Yes** from the menu. Resume station operation by selecting **No** from the menu. Enabling a station (disable = no) will clear corresponding station alarms that resulted from over/under current conditions.

Hold Sta: – Use this menu item to delay operation for this station. Select the hold duration from 01–30 days, Permanent or None. This option is useful when a specific station needs to be deactivated without affecting any of the programs.

Is Switch: – Use this menu item to assign the station to a switch. When the switch (station) is activated, the Master Valve or Pump will not actuate. The output will remain as 24 VAC



Cycles: – Using this menu item will result in additional start times without increasing the station runtime. Cycles will automatically divide the corresponding station runtime by the Station Cycles value and execute each resulting cycles after satisfying the program soak duration. Select from **01** (normal operation) through **04** cycles or you can select **Autocycle**. When selecting Autocycle, the Max Cycle duration and Auto Soak duration must be entered. Autocycle will then run the station up to the Max Cycle duration, wait for the Auto Soak duration to expire, then initiate another cycle until the total station runtime is completed.

Edit Name: – Use this menu item to assign a name description to the station. The naming format is XX-AA-YY, where XX represents the golf course hole number, AA represents the area description acronym and YY represents the sprinkler number within the area. By following the naming format, you can easily figure out where and what area the station is watering.

Area Description Acronym Examples

GR = Greens **DR** = Driving Range **TE** = Tee **CH** = Club House **FW** = Fairways
LA = Landscape **RF** = Rough **PG** = Putting Green **AP** = Approaches **MS** = Misc.

Last On: – This menu item will display the last activation current value that the satellite recorded for the station.

Nominal: – This menu item will display the nominal current value that the satellite recorded for the station. You can reset the value by selecting **Reset**. Use the Input Dial  to select **Reset** and press Up or Down arrows   to select. Once **Reset** is selected, Nominal values will default to 0 (Zero). The satellite will record the new value on the next station activation.

Note: Nominal values can also be updated by activating **Setup Amps** from the **Satellite Settings** menu or selecting **Reset** from the **Nominal** item under **Station Amps** menu in **Diagnostics**. Performing these function will reset all of the station’s nominal current values.

Tol +/- : – Use this menu item to set the individual station’s nominal current tolerance. This value will determine the station’s allowable current operating range. If the satellite subsequently determines that the station is operating outside of the allowable range, the satellite will disable the station and generate an alarm.

Alarm Events – This menu item will display any alarm events incurred from previous activation. Alarm event messages will disappear when the satellite detects that the fault has been fixed.

Pump Nomn: – This menu item will display the pump output nominal current value. This value can not be modified in this menu item. To reset this value, select **Reset** from the **Nominal:** menu item. This value will also reset when **Setup Amps** from the **Satellite Settings** menu is activated.

Scheduled Watering



The Network VP satellite features 64 fully-independent resident programs. With three types of programs to select from, you can further custom fit your irrigation programs to any landscape.

- **Basic Irrigation Program** will activate a station or group of stations with one start time on a daily basis. Each station will water for the duration specified in hours, minutes and seconds. Percent adjust and maximum number of simultaneous activate stations per program can be specified in this program.
- **Advanced Irrigation Program** will activate a station or group of stations with up to 24 start times. The 2-week calendar scheduling can be varied from All (daily), Alternate, Weekdays only, Weekends only, None (Off) or specific days dictated by you. Percent adjust and the number of simultaneous active stations can be specified in this program.
- **Grow-In Irrigation Program** will activate a station or group of stations for the length of their runtime. The program will repeat the cycle after the specified delay time expires and will repeat continuously between the set Start and End times. Percent adjust and the simultaneous activate stations can be specified in this program.
- **GMM (Group Multi-Manual)** will activate up to 64 Sequences with 6 stations per sequence. Each station can only be assigned to one sequence. GMM have a 5-day schedule with up to 24 start times.
Note: A program must be configured with the proper settings in order to run either automatically or manually.
- **Station Based Flow Management** - The Network VP supports station based flow management as downloaded by SitePro. When station based flow management is utilized, the downloaded station activity list can be viewed between **GMM** and **P01** within the **Scheduled Watering** menu. The station activity list cannot be edited at the satellite. Upon receipt, the satellite automatically creates traditional programs (P01 to P64) from the information contained in the station activity list. Traditional programs created from the station activity list are intended for manual irrigation and therefore do not include a start time. Placing a start time on any traditional program will disable the station activity list and prevent it from executing.

The configuration parameters are as follows:

P01 – Select the program number being created or modified. Network VP can have up to 64 programs plus a GMM.

100% – Percent adjustment parameter. Adjust the percentage according to the proper weather or season changes. You can adjust the program's watering from 10% – 250%. (Available for Basic, Grow-In and Advanced.)

Hold – Activate HOLD to suspend program activity. Select from NONE, TODAY, 02–30 Days and PERMANENT. (Available for Basic, Grow-In and Advanced)

Type – Select the type of program being created from Basic, Grow-In and Advanced.

Start time: – Enter the time to start the program cycle. Advanced programs can have up to 24 Starts. (Available for Basic, Grow-In and Advanced.)

End: – Enter the time the program will terminate watering. (Available only for Grow-In programs.)

Delay: – Enter the delay time between each program cycles. (Available only for Grow-In programs.)

Days: – Select the program's active days schedule ranging from Water Every 01 Days through 30 Days or selectively choose any Days-of-the-Week to irrigate. (Available only for Advanced programs.)

set> – When selecting Days-of-the-Week to irrigate, use set to activate or deactivate any days from the two-week schedule. (Available only for Advanced programs.)

Today's Day: – Select Today's designation when choosing the Water Every XX option. Example: When setting your program to water every 4th day and you want the cycle to start tomorrow, set 03 for Today. The **TODAY** number is increased at every **Day Change** until the **Water Every** number is met. (Available only for Advanced programs.)

Sta #: – Enter the stations and their runtimes that the program will activate.

Syringe: – Regardless of the programmed runtimes, if the syringe duration is set at a value from 01 through 99 minutes, all stations in that program will activate for that duration at start time. Disable Syringe by assigning 00 min for the duration. (Available only for Advanced programs.)





Repeats: – Program repeats can be set from 0–3 times. The program's total runtime will be multiplied by the number of repeats. Program repeat will activate immediately after the program soak duration is satisfied. (Available only for Advanced programs.)



Soak: – Soak is the delay time that the controller will wait before executing a station cycle or a program repeat. Soak is valuable to give irrigation time to penetrate the soil before continuing with the cycle. Without soak time, the soil will reach saturation resulting in water run off. Soak time can range from 00:00 (no delay) to 11:59 (Hours:Minutes). (Available only for Advanced programs.)















Simult: – Enter the maximum allowable stations that can simultaneously operate. This parameter can not be greater than the Max Sim Sta (Maximum Simultaneous Stations) in the Satellite Settings. (Available for Basic, Grow-In and Advanced.)

Basic Irrigation Program Setting:

Basic Irrigation Program example: Create Program 01 with stations 1–5 for 25 minutes each and stations 11–20 for 15 minutes each with a program adjustment of 110%. Set the start time at 6:30 am with five maximum simultaneous active station.

1. Press the Scheduled Watering Key . The cursor is initially located at the program selection field. Use the Input Dial -  + to select the program (P01–P64) you want to create or modify. For this example, select program 01.
2. Press the Right Arrow Key  to advance to the Percent Adjust field. Normally this setting will be 100% unless weather or other condition suggest that less or more irrigation time is needed. Use the Input Dial -  + to adjust the setting. For this example, set the %adjustment to 110%.

Note: Changing the percent adjustment of Program 01 in the Scheduled Watering  settings will also change the settings of Program 01 in % Adjust  settings.

3. Press the Down Arrow  to advance the cursor to the **Hold:** field. Use this option to suspend program operation. Select from **None**, **Today**, **02–30** days or **Permanent**. For this example, select **None**.
Note: Programs placed on Hold can still be activated by Manual Watering.
4. Press the Down Arrow  to advance the cursor to the **Type:** field. Use the Input Dial -  + to adjust the setting. For this example, select **Basic**.
5. Press the Down Arrow  to advance the cursor to the **Start time:** field. Use the Input Dial -  + and the Right Arrow Key  to select the appropriate program start time. For this example, set the start time to **06:30 am**.
6. Press the Down Arrow  to advance the cursor to the **Sta#:** field. Use the Input Dial -  + to select the correct value of the first station being irrigated. For this example, select station **01**.
7. Press the Right Arrow  to advance the cursor to the next value. This value will indicate the last station of the range. If irrigating only one station, this value should be the same as the first value. For this example, select **05**.
8. Press the Right Arrow  to advance the cursor to the next entry field. This entry field will indicate the runtime in hours, minutes and seconds (HH:MM:SS). Use the Input Dial -  + and the Right Arrow Key  to select the appropriate runtime value. For this example, set the value to **00:25:00**.
9. Repeat Steps 4–8 for Group Station 11–20 with 15 minutes of runtime.
10. Press the Down Arrow  to advance the cursor to the **Simult:** field. Use the Input Dial -  + to select the maximum allowable simultaneous active stations. For this example, set the value to **05**.

When finished, the display should read:

P 01 110% %05:02:30 (% indicates adjusted time of 5 hours, 2 minutes & 30 seconds total program runtime)

Hold: None

Type: Basic

Start time: 06:30am

Sta#: 01–05 00:25:00



























Sta#: 11–20 00:15:00





Sta#: ----- :-:--:--

Simult: 05

Advanced Irrigation Program Setting:

Advance Irrigation Program example: Create program 2 with stations 6–10 for 15 minutes each with no percent adjustment. Set the start time 01 at 5:45 am every Monday, Wednesday and Friday only. Set the maximum simultaneous active station to 5.

1. Press the Scheduled Watering Key . The cursor is initially located at the program selection field. Use the Input Dial  to select the program (P01–P64) you want to create or modify. For this example, select program 02.
2. Press the Right Arrow Key  to advance to the Percent Adjust field. Normally this setting will be 100% unless weather or other condition suggest that less or more irrigation is needed. Use the Input Dial  to adjust the setting. For this example, no adjustment is needed.
3. Press the Down Arrow  to advance the cursor to the **Hold:** field. Use this option to suspend program operation. Select from **None**, **Today**, **02–30** days or **Permanent**. For this example, select **None**.
4. Press the Down Arrow  to advance the cursor to the **Type:** field. Use the Input Dial  to adjust the setting. For this example, set the Type to **Advanced**.
5. Press the Down Arrow  to advance the cursor to the **Days:** field. Use the Input Dial  to select the program activation interval from 01–30 days. Select 01 for everyday, 02 for every other day, 03 for every third day and so on. The example does not call for a set interval. Leave the **Days:** setting to **SMTWTFS**.
6. Press the Down Arrow  to advance the cursor to the **Set:** field. Use the Input Dial  to select from any of the preset intervals (All, Alternate days, Weekdays only, Weekends only, None or User set). To create your own program activation interval, select **Set:**. Use the Right Arrow Key  to select the day of the week you want to irrigate and use the Input Dial  to activate (X) or deactivate (blank) the selection. For this example, activate M (Monday), W (Wednesday) and F (Friday) only. MWF of the 1st and 2nd week should have an **X** mark under while the rest are blank.
7. Press the Down Arrow  to advance the cursor to the **Start:** field. The first entry field will indicate the start time number. Each program can have a maximum of 24 start times. Use the Input Dial  to choose the start time being created or modified. Press the Right Arrow Key  to advance to the time entry field. Use the Input Dial  to select the start time in hours and minutes (HH:MM). Repeat Step 7 for additional start times. For this example, set start time **01** to **05:45am**.
8. Press the Down Arrow  to advance the cursor to the **Syringe:** field. Use the Input Dial  to activate Syringe by entering a syringe runtime. If activated, the program will run all stations for the duration specified, regardless of the individual station runtimes. Leave the syringe runtime at **00** min.
9. Press the Down Arrow  to advance the cursor to the **Repeats:** field. Use the Input Dial  to enter the amount of repeats the program will execute after activation. Leave the Repeat value to **0**.
10. Press the Down Arrow  to advance the cursor to the **Soak:** field. Use the Input Dial  to enter soak time. The soak time will indicate the delay before the program will repeat or cycle again. Leave the soak time to **-- : -- : --** for no soak delay.
11. Press the Down Arrow  to advance the cursor to the **Sta#:** field. Use the Input Dial  to select the correct value of the first station being irrigated. For this example, select station **06**.
12. Press the Right Arrow  to advance the cursor to the next value. This value will indicate the last station of the range. If irrigating only one station, this value should be the same as the first value. For this example, select station **10**.

13. Press the Right Arrow  to advance the cursor to the next entry field. This entry field will indicate the runtime in hours, minutes and seconds (HH:MM:SS). Use the Input Dial -  + and the Right Arrow Key  to select the appropriate runtime value. For this example, set the value to **00:15:00**.
14. Press the Down Arrow  to advance the cursor to the **Simult:** field. Use the Input Dial -  + to select the maximum allowable simultaneous active station. For this example, set the value to **05**.

When finished, the display should read:















```

P 02 100% 01:15:00 (01:15:00 = 1 hours & 15 minutes total program runtime)
Hold: None
Type: Advanced
Days: SMTWTFSSMTWTFSS
Set>: X X X X X X X
Start: 01 05:45am
Syringe: 00 min
Repeats: 0
Soak: --:--:--
Sta#: 06-10 00:15:00
Sta#: ----- --:--:--
Simult: 05













```

Grow In Irrigation Program Setting:

Grow In Irrigation Program example: Create program 3 with stations 21–30 for 5 minutes each with no percent adjustment. Set the start time at 6:30 am and the end time at 4:00 pm. Set the delay for 2 hours and 15 minutes and the maximum simultaneous active station to 5.

1. Press the Scheduled Watering Key . The cursor is initially located at the program selection field. Use the Input Dial -  + to select the program (P01–P64) you want to create or modify. For this example, select program 03.
2. Press the Right Arrow Key  to advance to the Percent Adjust field. Normally this setting will be 100% unless weather or other condition suggest that less or more irrigation is needed. Use the Input Dial -  + to adjust the setting. For this example, no adjustment is needed.
3. Press the Down Arrow  to advance the cursor to the **Hold:** field. Use this option to suspend program operation. Select from **None**, **Today**, **02–30** days or **Permanent**. For this example, select **None**.
4. Press the Down Arrow  to advance the cursor to the **Type:** field. Use the Input Dial -  + to adjust the setting. For this example, set the Type to **Grow-In**.
5. Press the Down Arrow  to advance the cursor to the **Start:** field. This start time will indicate the starting point of the Grow-In cycle. Use the Input Dial -  + to select the start time value. Use the Left and Right Arrow Keys   to navigate between the Hours and Minutes fields. For this example, set the start time to **06:30am**.
6. Press the Down Arrow  to advance the cursor to the **End:** field. This end time will indicate the end point of the Grow-In cycle. Use the Input Dial -  + to select the end time value. Use the Left and Right Arrow Keys   to navigate between the Hours and Minutes fields. For this example, set the end time to **04:00pm**.

(Continued to the next page)















7. Press the Down Arrow  to advance the cursor to the **Delay:** field. This delay time will determine the wait time between program cycles. Use the Input Dial -  + to select the delay time value. Use the Left and Right Arrow Keys   to navigate between the Hours and Minutes fields. For this example, set the delay time to **02:15**.
8. Press the Down Arrow  to advance the cursor to the **Sta#:** field. Use the Input Dial -  + to select the correct value of the first station being irrigated. For this example, select station **21**.
9. Press the Right Arrow  to advance the cursor to the next value. This value will indicate the last station of the range. If irrigating only one station, this value should be the same as the first value. For this example, select station **30**.
10. Press the Right Arrow  to advance the cursor to the next entry field. This entry field will indicate the runtime in hours, minutes and seconds (HH:MM:SS). Use the Input Dial -  + and the Right Arrow Key  to select the appropriate runtime value. For this example, set the runtime to **00:05:00**.
11. Press the Down Arrow  to advance the cursor to the **Simult:** field. Use the Input Dial -  + to select the maximum allowable simultaneous active station. For this example, set the value to **05**.

When finished, the display should read:





```
P 03 100% 00:50:00
Hold: None
Type: Grow In
Start: 06:30am
End: 04:00pm
Delay: 02:15 (hr:min)
Sta#: 21-30 00:05:00
Sta#: ----- :--:--:--
Simult: 05
```

GMM (Group Multi-Manual) Setting:

GMM example: Create Group Multi-Manual with two sequences. Sequence 1 will have stations 1, 5, 7 and 9 with a runtime of 15 minutes per station. Sequence 2 will have stations 2, 3, 4, 11, 12 and 13 with a runtime of 20 minutes per station. The GMM will have two start times, one at 9pm and the other at 3am. GMM shall run only on Sundays, Tuesdays, Thursdays and Saturdays.

1. Press the Scheduled Watering Key . The cursor is initially located at the program selection field. Use the Input Dial -  + to select **GMM** which is located between P64 and P01.
2. Press the Down Arrow  to advance to the **Set - - Act days** field. This field allows you to select the days of the week the GMM will activate. Use the Right and Left arrows   to navigate between days of the week and use the Input Dial -  + to activate/deactivate a day. All days are deactivated as the factory default. To activate Sunday, Tuesday, Thursday and Saturday, place an **X** under its corresponding initial.
3. Press the Down Arrow  to advance to the **Start:** field. Use the Right and Left arrows   to navigate to the start number and time. Use the Input Dial -  + to select the Start number and enter the start time. Set Start time **01** to **09:00pm** and Start time **02** to **03:00am**.
4. Press the Down Arrow  to advance to the **Seq#:** field. Use the Right and Left arrows   to navigate between the Sequence number and runtimes. Use the Input Dial -  + to select the sequence number and set sequence station runtimes. Set Sequence **01** to **00:15:00** of runtime.

(Continued to the next page)

- Press the Down Arrow  to advance to the **Sta** field. Use this field to enter the station numbers that corresponds to the currently displayed sequence. Use the Right and Left arrows   to navigate between the station number fields. Use the Input Dial -  + to select station number. Set Stations **01**, **05**, **07** and **09** to sequence **01**.



Repeat Steps 4 and 5 to set additional sequences. Set a 20-minute station runtimes to sequence **02**. Set stations **02**, **03**, **04**, **11**, **12** and **13** to sequence 02.

Note: Network VP will allow you to set a station that is already assigned to another sequence but it will delete that station number from the sequence it was previously assigned.

When finished, the display should read:



```
GMM S M T W T F S 00:35:00
Set X X X X X Act days
Start: 01 09:00pm
Seq#: 01 00:15:00
St 01 05 07 09 -- --
Clear GMM: No
```

```
GMM S M T W T F S 00:35:00
Set X X X X X Act days
Start: 02 03:00am
Seq#: 02 00:20:00
St 02 03 04 11 12 13
Clear GMM: No
```



- To clear GMM, press the Down Arrow  to advance to the **Clear GMM:** field. Use the Input Dial -  + to No or Yes. Select Yes if you want to clear the GMM parameters. You must press the Up Arrow  to after selecting Yes to activate selection.

Station Based Flow Management:

The SBF (Station Based Flow) screen can be accessed from the Scheduled Watering menu. Follow the steps to access.

- Press the Scheduled Watering Key . The cursor is initially located at the program selection field. Use the Input Dial -  + to select **SBF List** which is located between GMM and P01.

Note: The SBF List is only available after a successful download from SitePro.

- Use the Right arrow  to navigate to the event number.
- Use the Input Dial -  + to select the event number you want to review.

SBF (Station Based Flow) Sample Screen:

```
SBF List Event 001 (1st line will indicate the Event Number)
Start 12:00am S22 (2nd line will indicate the Start Time followed by the Station Number)
Run 00:10:00 P26 (3rd line will indicate the Runtime [Hrs:Min:Sec] followed by the Program Number)
Program Start (80) (4th line indicate Miscellaneous Functional Code)
```

Note: Editing to the SBF List is not allowed in the satellite level. SBF modifications must be made in SitePro and downloaded back to the satellite to update.

Manual Watering













 The Manual Watering functions are used for additional watering if the irrigation program is not sufficient. They can also be used to troubleshoot each station for proper operation. Pressing the Manual Watering Key will access three manual irrigation functions; Multi-Manual, Syringe and Program.

M-Manual - Select M-Manual to activate a station or group of stations with a specified runtime.

Multi-Manual Station Activation Directions

Manual station activation example: Activate stations 1–12 with a runtime of 5 minutes each and limit watering to 3 stations simultaneously.

Note: The Multi-Manual function is limited to the maximum simultaneous station settings of the satellite. In cases where a program is running and a multi-manual activated, the satellite will activate all stations specified in the multi-manual in addition to the currently activated stations. Thus, the multi-manual will allow the satellite to exceed the maximum simultaneous station settings.

1. Press the Manual Watering Key .
2. The cursor should be located in the Manual field, use the Input Dial -  + to select **M-Manual**.
3. Press the Down Arrow  to advance the cursor to the **Sta#:** field. Use the Input Dial -  + to select the correct value of the first station being irrigated. For this example, select station **01**.
4. Press the Right Arrow  to advance the cursor to the next value. This value will indicate the last station of the range. If irrigating only one station, this value should be the same as the first value. For this example, select station **12**.
5. Press the Right Arrow  to advance the cursor to the next entry field. This entry field will indicate the runtime in hours, minutes and seconds (HH:MM:SS). Use the Input Dial -  + and the Right Arrow Key  to select the appropriate runtime value. For this example, set the value to **00:05:00**.
6. Press the Down Arrow  to advance the cursor to the next entry field. Notice that a new Station: line was created. Fill this line only if irrigating multiple ranges of stations, otherwise, leave this line blank.
7. Press the Down Arrow  to advance the cursor to the **Simult:** field. Use the Input Dial -  + to select the maximum simultaneous irrigating stations. For this example, set the value to **03**.
8. Once finished, press the Start Key  to activate or press the Home Key  to cancel and revert back to the default display.

Note: Pressing the Home Key will save the entered values.

When finished, the display should read:

```
Manual: M-Manual
Sta#: 01-12 00:05:00
Sta#: ----- --:--:--
Simult: 03
Press START to water
```

When reviewing the Multi-Manual program by pressing the Manual Watering button, the display will deduct the stations that watered or currently watering to the list.

Modifying the Multi-manual will append the added stations to the currently running manual. Currently running stations will not be affected. VP will run the stations in sequential order disregarding the order it was entered.









Syringe - Choose Syringe to activate all the stations in a selected irrigation program for a specified runtime.

Note: The Maximum number of simultaneous stations set in the program still applies.

Manual Syringe Activation Directions

Syringe activation example: Manually activate all the stations in Program 3 for 2 minutes each.

Note: An irrigation program must be configured to activate Manual Syringe.

1. Press the Manual Watering Key .
2. The cursor should be located in the Manual field. Use the Input Dial -  + to select **Syringe**.
3. Press the Down Arrow  to advance the cursor to the **Runtime:** field. Use the Input Dial -  + to select the correct value of the runtime in minutes. For this example, set the value to **02** minutes.
Note: The Runtime setting in Syringe will not affect the actual runtime in the program.
4. Press the Down Arrow  to advance the cursor to the **Program:** field. Use the Input Dial -  + to select the correct program to syringe. For this example, select program **03**.
5. Once finished, press the Start Key  to activate or press the Home Key  to cancel and revert back to the default display.

Note: Pressing the Home Key will save the entered values.

When finished, the display should read:







*Manual: Syringe
Runtime: 02 min
Program: 03
Press START to water*

Start Program - Select Start Prog to activate a watering program regardless of its set start time.

Manual Program/GMM Activation Directions

Start Program example: Manually activate Program 36.

Note: An irrigation program must be configured to activate Manual Program. A program on hold can still be manually activated.

1. Press the Manual Watering Key .
2. The cursor should be located in the Manual field. Use the Input Dial -  + to select **Start Prog**.
3. Press the Down Arrow  to advance the cursor to the **Program:** field. Use the Input Dial -  + to select the correct program value or GMM. For this example, select program **36**.
4. Once finished, press the Start Key  to activate or press the Home Key  to cancel and revert back to the default display.

Note: Pressing the Home Key will save the entered values.

When finished, the display should read:



*Manual: Start Prog
Program: 36
Press START to water*

Note: Manually starting a GMM will prevent subsequent scheduled GMM starts. To reestablish the GMM scheduled starts, you will be required to download the GMM program again from SitePro or reassign the GMM's active days at the satellite.





% (Percent) Adjust

 The percent adjust function allows you to fine tune irrigation programs. With weather conditions changing constantly, Percent Adjust allows you to tune your system easily without changing all the values in the program.





% Adjust Directions

1. Press the % Adjust Key . The cursor is initially located at the Satellite % Adjust field. Use the Input Dial  to adjust the satellite watering up to 900% or down to 1%.

Note: The satellite adjustment will affect all stations and programs universally. Do not adjust the satellite % settings if adjustment is station or program specific.

2. Press the Down Arrow  to advance the cursor to the **Program:** field. The first entry field will be the program selection field. Use the Input Dial  to select the program being adjusted. Press the Right Arrow  to advance the percent adjustment field. Use the Input Dial  to adjust the program watering up to 250% or down to 10%. Repeat step 2 to adjust additional programs.

Note: Do not adjust the program % setting if adjustment is station specific.

3. Press the Down Arrow  to advance the cursor to the **Station:** field. The first entry field will be the station selection field. Use the Input Dial  to select the station being adjusted. Press the Right Arrow  to advance to the percent adjustment field. Use the Input Dial  to adjust the station watering up to 900% or down to 000%. Repeat step 3 to adjust additional stations.

Note: Adjusting the station's watering to 000% will prevent it from running within a program. Multi-Manual and Syringe are not affected by the % Adjustment.

Diagnostics

 The Diagnostics function of the Network VP satellite allows for easy system troubleshooting. Within this function, the user can monitor the satellite's internal voltages as well as check the satellite's firmware version.

Use the Input Dial  to navigate through the menus while in the **Menu:** field.



Menu: Link Monitor – This menu item allows you to monitor communication network traffic.













Menu: System Monitor – This menu item allows you to monitor all the satellites in the system.

Menu: Revision – This menu item will display the satellite firmware version and creation date.

Menu: Power-Up Detect – This menu item will display the number of detected stations, number of detected sensors. It will also display the date and time of the last power-down (PD) and last power-up (PU). Press the Down arrow  to scroll down the informations.

Menu: Seq Stations – This menu item allows you to activate all the stations sequentially. Use the Input Dial  to set the time duration from 0.01 sec, 0.1 sec, 0.5 sec, 1 sec, 5 sec, 10 sec, 1 min or 5 min. The user can observe the operation of each station when troubleshooting the system using this option.

Menu: Station Test – Use this menu item to test individual stations. Press the Down arrow  to access the station number field. Select the station you want to test and press START key . You can step to the next or previous station number by using the Input Dial .

- Menu: Station Amps** – Use this menu item to review each of the station’s last recorded voltage amperage, nominal amperage value, tolerance value, alarm events, pump nominal amperage value. Use the Input Dial  to scroll through the available stations. Use the Down arrow  to scroll down to the data fields. You can reset the **Nominal** amperage value within this menu item by selecting **Reset** using the Input Dial  and pressing the Down arrow  to activate.
- You can modify the Tolerance (**Tol +/-**) amperage value within this menu item by using the Input Dial  to select the desired value.
- You can also enable or disable the station within this menu item. Enabling or disabling the station in this screen will also be reflected in the **Station Setting’s Disable** setting. Enabling the station will also clear any corresponding over/under current alarms for the station. To disable, select **Yes** in the **Disable** field using the Input Dial . To enable the station, select No in the Disable field using the Input Dial.
- Menu: Send Ctrl Code** – Use this menu item to send Control Codes. These control codes are set in SitePro. To send a control code, navigate to the **Code** field using the Down arrow  and use the Input Dial  to select the code you want to send. Press the **Start** key  to send.
- Menu: VA Monitor** – This menu item allows you to monitor the satellite’s amperage, voltages and temperature in real-time. This allows you to troubleshoot the satellite’s internal circuit voltages.
- Menu: Event Codes** – This menu item will display the satellite’s Event Code log. You can clear the log from this option. Navigate to the **Clear** field using the Down arrow , select **Yes** using the Input Dial  and press the Down arrow  to activate.
- Menu: Link Settings** – Use this menu item to view the satellite’s communication settings. Parameters can not be edited here.

Troubleshooting Guide

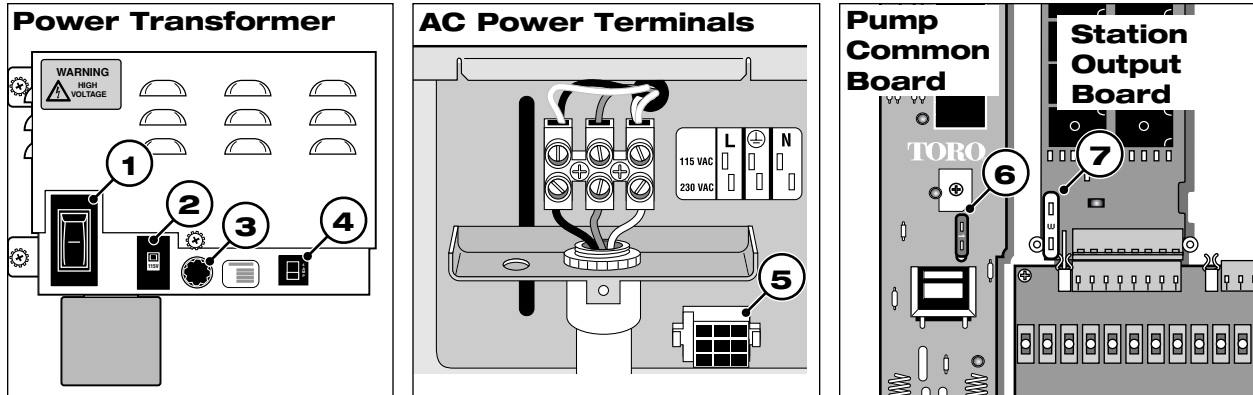

Electrical Protection

- 1 - Main Power Switch / 1.5A Circuit Breaker** - Protects the controller from a short circuit on the incoming power line.
- 2 - Input Voltage Select Switch** - Set the input power supply to 115 VAC or 230 VAC
- 3 - 3.2A Slow Blow Fuse** - Protects the controller from a short circuit on the 24 VAC field common wire or from excessive simultaneous activated solenoids.
- 4 - 4.0A Circuit Breaker** - Protects logic circuit boards, such as the Timing Mechanism and Distribution Board from a short circuit.
- 5 - Distribution Board Power Socket** - Power supply connection to the Distribution Board and the 24 VAC Bus Bar.
- 6 - 1.0A Fuse** - Protects the 24 VAC Pump Circuit from a short circuit.

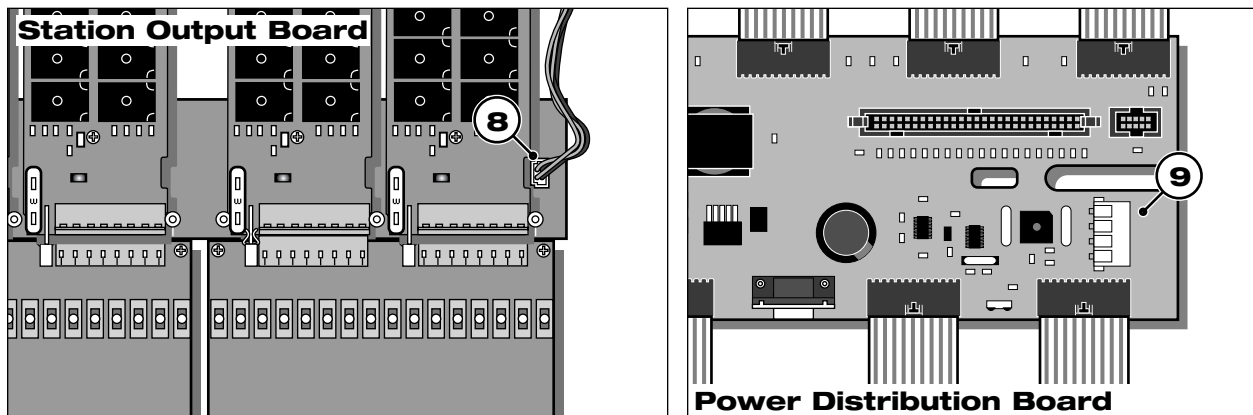

- 7 - 3.0A Fast Blow Fuse** - Protects the individual 8-station output boards from a 24 VAC field wiring short circuit, shorted solenoid or excessive simultaneous activated solenoids.

Voltage Checks

- 8 - Green/Black Cable Assembly** - 24 VAC power supply. It is protected by a 3.2A fuse.
- 9 - White/Red Cable Assembly** - 13 VAC power supply. It is protected by the 4.0A circuit breaker.

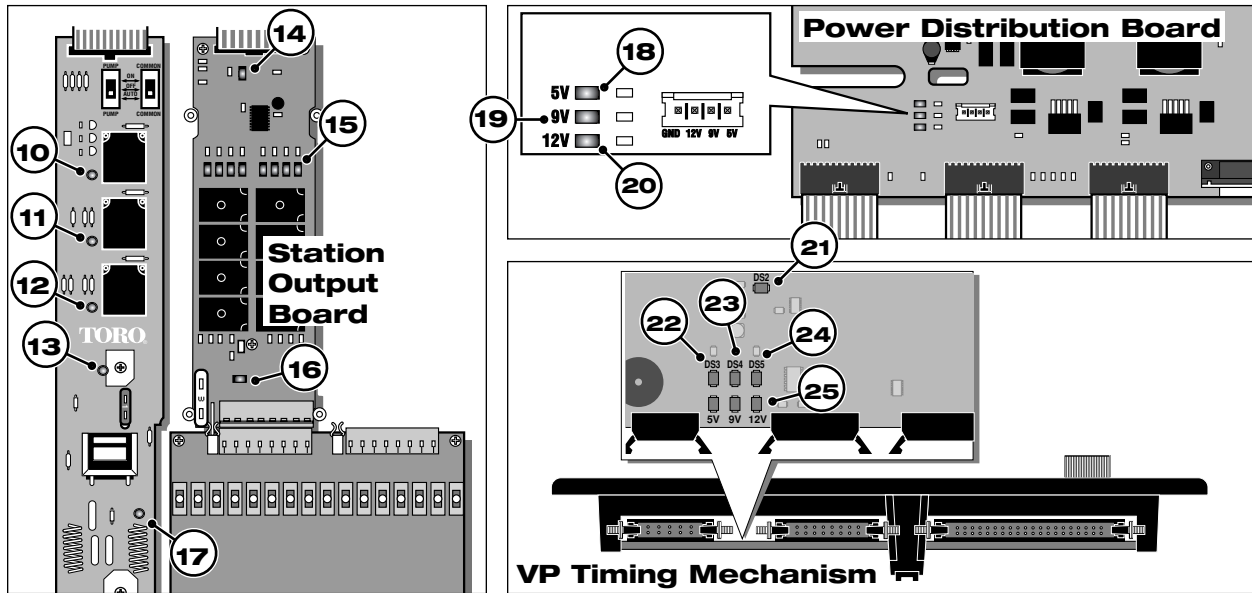

LED Indicators

- 10 - Pump Relay LED Indicator** - When illuminated, the pump relay is activated.
- 11 - Common Relay LED Indicator** - When illuminated, the common relay number 1 is activated.
- 12 - Common Relay LED Indicator** - When illuminated, the common relay number 2 is activated.
- 13 - 24 VAC Output LED Indicator** - When illuminated, it indicates the presence of 24 VAC across the 24 VAC Bus Bar supplied by the Green/Black power wire assembly.
- 14 - 8-Station Output Module Logic LED Indicator** - When illuminated, communication between the Distribution board and the output module is present. If any one of the output module's indicator is not illuminated, check the ribbon cable for proper connection.
 If all of the module's indicator are not illuminated, check the following for possible causes:
 - Tripped 4.0A Circuit Breaker
 - Loss of Power Supply
 - Transformer Malfunction
 If the circuit breaker is tripped, the Distribution board or Timing Mechanism most likely experienced a short circuit. Check the fuses and replace as necessary.
- 15 - 24 VAC Output LED Indicator (One per Station)** - The green station LED indicator will illuminate when the 8-station output module receives a command to activate a station, either by manual irrigation, irrigation program or by a hand-held command. It indicates that the output module received a signal and in response activated the corresponding relay. It does not indicate the presence of 24 VAC in the station terminal. The LED will not illuminate when using the manual switch to activate a station.
- 16 - 24 VAC Output LED Indicator** - When illuminated, it indicates the presence of 24 VAC across the 24 VAC Buss Bar supplied by the Green/Black power wire assembly. If the red LED is not illuminated, check the fuse for that module. If the fuse is blown, a short circuit on the 24 VAC field wires or shorted solenoid could be the cause. If all of the red LED's are not illuminated, check for blown 3.2A fuse, loose power cable connection to the 24 VAC Buss Bar or damaged solder joints between the fuse holder and the 24 VAC Bus Bar.
- 17 - Pump Output LED Indicator** - When illuminated, it indicates voltage is present at the pump output terminal.
- 18 - 5 Volt LED Indicator** - When illuminated, it indicates the presence of 5 VDC to the logic circuits. 5 VDC is used by the Modem Module, Output Modules, Pump Module and the Timing Mechanism.
- 19 - 9 Volt LED Indicator** - When illuminated, it indicates the presence of 9 VDC to the logic circuits. 9 VDC is used by the Output Modules, Pump Module and the Timing Mechanism.
- 20 - 12 Volt LED Indicator** - When illuminated, it indicates the presence of 12 VDC to the logic circuits. The 12 VDC is used by the Modem Module and Timing Mechanism.
- 21 - DS2 LED Indicator** - This red LED will blink as an indication that the Timing Mechanism is receiving proper voltages and signals.
- 22 - DS3 LED Indicator** - This green TX LED will flash during communication transmission much like the modem TX LED.
- 23 - DS4 LED Indicator** - Not utilized.
- 24 - DS5 LED Indicator** - This red RX LED will flash while receiving communication data much like the modem RX LED.
- 25 - 5, 9 & 12 Volts LED Indicator** - When illuminated, each LED indicates the presence of their corresponding voltages in the Timing Mechanism. The ribbon cable assembly connected to the J10 socket provides the voltage supply.

Lithium Battery Replacement Procedure



WARNING! DANGER OF EXPLOSION IF BATTERY IS INSTALLED INCORRECTLY. REPLACE ONLY WITH THE SAME OR EQUIVALENT TYPE OF BATTERY. ALWAYS DISPOSE OF USED BATTERIES ACCORDING TO THE MANUFACTURER'S INSTRUCTIONS.

A 3.9V Lithium battery (P/N 363-2200) is installed behind the timing mechanism circuit board to sustain the controller's time and date for approximately 10 years without any additional power.

1. Place the controller's power switch to OFF.
2. Remove the timing mechanism from the cabinet by unscrewing the two retaining screws that secure the timing mechanism's face plate. See first figure below.
3. Disconnect the ribbon cable that connects the timing mechanism to the distribution board.
4. Remove the timing mechanism's circuit board by pushing the retaining clip downward while carefully pulling onto the circuit board. See second figure below.
5. Replace the old Lithium battery and secure a new battery.
6. Reattach the circuit board and ribbon cable into the timing mechanism.
7. Reinstall the timing mechanism into the controller and place the power switch back to ON.

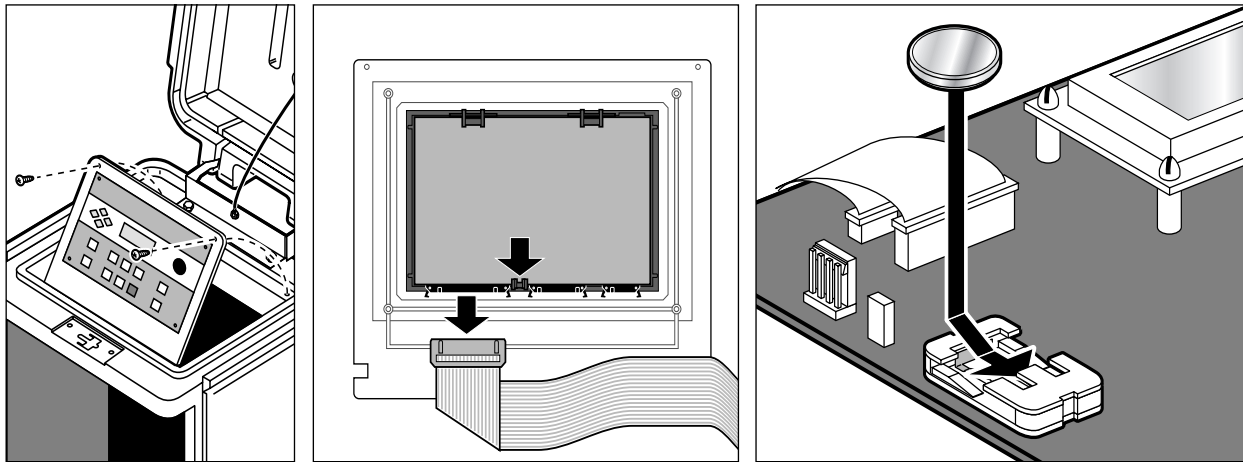

Electromagnetic Compatibility

Radio complies with FCC Part 22 and Part 90 of the FCC Rules

Domestic: This equipment has been tested and found to comply with the limits for a FCC Class A digital device, pursuant to part 15 of the FCC Rules. These limits are designed to provide reasonable protection against harmful interference when the equipment is operated in a commercial environment. The equipment generates, uses, and can radiate radio frequency energy and, if not installed and used in accordance with the instruction manual, may cause harmful interference to the radio communications. Operation in a residential area is likely to cause harmful interference in which case the user will be required to correct the interference at his own expense.